

Calibration of the Herschel HIFI Instrument using Gas Cell Measurements

Ronan D. Higgins*[§], David Teyssier[†], John C. Pearson[‡], Christophe Risacher** and Neil A. Trappe*

* Dept. of Experimental Physics, National University of Ireland, Maynooth,
Co. Kildare, Ireland

[†]Herschel Science Centre,
European Space Astronomy Centre (ESAC), 28691 Villanueva de la Canada, Madrid, Spain.

[‡]Jet Propulsion Laboratory,
California Institute of Technology, Pasadena, CA 91109, USA

** SRON (Netherlands Institute for Space Research),
Landleven 12, 9747 AD, Groningen, the Netherlands

[§]Email: daniel.r.higgins@nuim.ie

Abstract—The Heterodyne Instrument for the Far-Infrared (HIFI) was launched aboard the Herschel space telescope on the 14th of May 2009. HIFI’s frequency range is spread over 7 mixer bands. Bands 1-5 (480-1270 GHz) use Superconducting-Insulator-Superconducting (SIS) mixer technology while bands 6 & 7 (1410-1910 GHz) use Hot Electron Bolometer (HEB) mixer technology. HIFI is a double sideband instrument and hence contains both the upper and lower sideband of the down converted sky signal. The gain in the upper and lower sideband is not always equal. This effect introduces a calibration uncertainty that must be understood in order to achieve the HIFI calibration goal of 3%.

To determine the frequency dependent sideband ratio for each mixer band, a gas cell test set up was developed [1]. During the instrument level testing a number of simple (¹²CO, ¹³CO and OCS) and complex (CH₃CN and CH₃OH) molecules were observed using the HIFI instrument. Using a radiative transfer model with the measured pressure and optical path length of the gas cell and molecular line parameters taken from the JPL and HITRAN catalogs, model spectra can be generated. By comparing the generated spectra with the observed spectra the sideband gain can be determined.

In this paper we present the analysis of ¹²CO gas cell data in bands 1 & 2 and the application of the

determined side gain ratios to flight data.

I. INTRODUCTION

HIFI is a one of three instruments on board the Herschel Space Observatory. Using heterodyne techniques it provides very high spectral resolution ($R = \nu/\Delta\nu \geq 10^6$ – 10^7) from 480–1270 GHz and 1410–1910 GHz for two polarizations. This high resolution promises to open a new window on the chemistry and kinematics of the cold universe [2].

The heterodyne technique achieves high resolution spectra by beating the sky signal with an instrument produced monochromatic signal of a similar frequency close to the sky frequency of interest. This local signal is typically known as the local oscillator (LO) signal. The two signals are added together at the mixer which reacts to the beat frequency of the two signals. This down converted signal is known as the intermediate frequency (IF). Depending on the mixer characteristics a 2.4 to 4GHz band of the sky signal is down converted either side of the LO frequency, these bands are known as the sidebands.

HIFI’s frequency coverage is spread over 7 bands. Each band has two mixer blocks which detect orthogonal polarizations. Each mixer is coupled to two LO chains covering approximately half of the

mixer band frequency coverage. HIFI uses two types of mixing elements. Bands 1-5 (480–1270 GHz) use Superconductor-Insulator-Superconductor (SIS) technology and bands 6 & 7 use Hot-Electron-Bolometer technology to mix sky and LO signals. Both technology use superconducting techniques to downconvert the signal albeit via different mechanisms, for a review of mixer technology see [3].

HIFI aims to have unprecedented calibration accuracy for a heterodyne instrument. A major source of calibration error in ground based telescope is atmospheric perturbations. By going to space HIFI opens up new parts of the sub-mm spectrum but also the vacuum of space removes a large calibration error. The main calibration errors in HIFI will be from the telescope optics and the instrument itself. The main sources of calibration error for HIFI come from internal standing waves, hot and cold load coupling and temperature and mixer sideband gain ratio. Standing waves manifest themselves in numerous ways in a heterodyne systems and can be seen on the spectra baseline but also more subtly in the mixer sensitivity due to internal reflection in the LO mixer cavity, see [4] for a review.

Side band gain ratio is a bi-product of the HIFI mixer set up. The HIFI mixers are double side band (DSB) mixers and hence have an upper and lower side band in the down converted spectra. The separation of side bands in the mixer setup is a common component in ground based telescope however at the time of HIFI development the technique was still in a development phase. HIFI separates the sideband in the data processing pipeline. Using the principle that by changing the LO frequency spectral lines in the upper and lower side band move in opposite directions it is possible to deconvolve DSB spectra into its SSB (single side band) components, see [5]. For wide band spectrometers such as HIFI the change in gain across the upper and lower side bands can introduce a significant calibration error. The side band gain effect can be removed during the deconvolution process however knowledge of the side band gain ratio is required.

This paper discusses the gas cell tests undertaken during instrument level testing (ILT) phase to determine the side band gain variation across the HIFI frequency coverage. The effect of side band ratio on calibration accuracy will be discussed in section 2. The gas cell set-up will be discussed in section 3. Section 4 details the gas cell line fitting and the extraction of the side band ratio from this data. Finally section 5 details the application of side band

ratio to flight data taken during the performance verification phase of HIFI.

II. CALIBRATION ERRORS

As HIFI aims for unprecedented calibration accuracy in a heterodyne system all efforts were made in the instrument level tests to quantify and understand the sources of calibration error in the system. 2 of the main sources of calibration error within HIFI are standing waves and the mixer sideband ratio.

A. Standing waves

Standing waves are a common feature in radio and sub-mm telescopes as the telescope and instrument optics are comparable with the radiation wavelength. Standing waves occur when a signal is reflected between 2 surfaces. The reflected signal interferes with the incoming signal. Depending on the phase of the signal when reflection occurs, the interference can be constructive or destructive. When this interference is viewed from a broadband perspective it appears as sinusoidal intensity variation with frequency. From the period of this modulation one can determine the distance between 2 reflecting surfaces as follows:

$$d = c/2P \quad (1)$$

where P is the standing wave period in frequency, c is the speed of light and d is the distance between the 2 surfaces.

The main source of standing waves in ground based telescopes is from the secondary mirror. This was considered in the design of the Herschel secondary mirror and the inclusion of scattering cone has almost completely removed this effect. However even though great efforts were made to reduce standing waves they are still seen in the HIFI internal optics. Standing waves are seen in both the sky and local oscillator signal paths.

Standing waves in the sky path, be it from the calibration loads or the sky, appear as a modulation on the spectrometer output. The problem is complicated further by the double side band nature of HIFI. The standing wave in figure 1 is the result of the interference between the standing wave in the the upper and lower sideband signal.

Standing waves in the LO path are not as apparent as those in the sky signal path but can have a detrimental effect on certain observing modes such as frequency switch modes [6]. Standing waves in the LO path modulate the LO power and hence the sensitivity of the mixer. Figure 2 shows the effect of a standing wave on the mixer pump level. A fraction

of the LO power is reflected between the LO unit and mixer causing a modulation in the LO power and hence mixer sensitivity. The effect of standing waves in the LO signal path is discussed in detail in [4].

The standing wave seen in the HEB bands is of another form. Like the sky path standing wave it is seen as a broadband modulation on the spectrum baseline however the origin of the reflection cavity is not in the instrument optics but in the IF electrical amplification chain. Due to an impedance mismatch between the HEB mixer and the first amplifier not all of the signal is transmitted and some is reflected back and forth between the 2 component along 182mm of coaxial cable. In bands 1-5 an electrical isolator is present absorbing any reflected signal. However due to a late design change in IF bandwidth for the HEB band no suitable isolator was available and hence reflected signal become a problem. In an ideal system the standing waves would cancel in the calibration routine. However the HEB impedance is a very sensitive to small fluctuations in LO and sky power which change the standing wave shape and leads to a residual between the On and Off phases. The impedance of HEB and the proposed solution to remove this standing wave is discussed in reference [7].

Correcting baselines for the standing wave effects seen in figure 1 is a typical chore of a radio astronomer and a number of tools are available for this task. However complete removal of all standing wave effects is not entirely possible. Standing waves from the temperature loads can limit the absolute temperature calibration possible and the standing wave amplitude must be taken as a calibration error.

B. Side band ratio

As stated previously, HIFI is a double side band instrument and contains signal from both the upper and lower sideband. The basic HIFI calibration contains 4 different observation phases, (On source, Off source, Hot load, cold load) which when combined together in equation 2 remove the systematic effects (assuming the instrument is stable over the course of the data acquisition) and return a temperature calibrated DSB spectra.

$$\frac{On - Off}{Hot - Cold} \quad (2)$$

In an ideal mixer with an equal gain in both sidebands, the spectral line intensity for an unconfused line (i.e. not blended with a line from the other side band) can be calculated simply by multiplying the

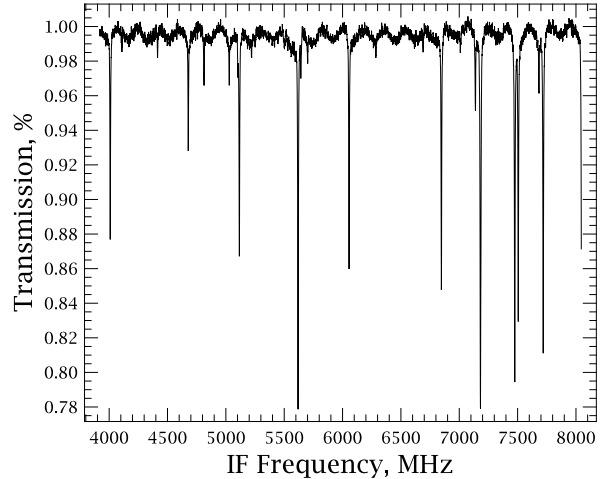

Figure 1. Plot of Methanol data taken at 645.999 GHz showing a 170 MHz period standing wave corresponding to internal reflection in a cavity of length ~ 88 cm

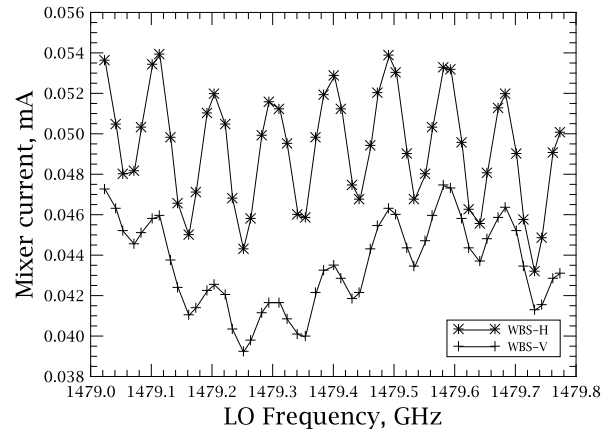

Figure 2. Plot of mixer currents for both H and V mixers. For this test the LO power is kept constant and the LO frequency is changed. In the mixer current vs. LO Frequency plot 2 standing waves are apparent, a 92MHz modulation corresponding to a distance between the LO source unit and the mixer focus and a 680 MHz period standing wave corresponding to an reflection between the diplexer rooftop mirror and the mixer focus.

line intensity by 2. However the gain response across a mixer band is not necessarily uniform.

HIFI observes 2 sidebands of 4.0 (bands 1-5) or 2.4 GHz (bands 6 & 7) either side of the LO Frequency. At the upper end of the IF band a 16 GHz frequency difference is seen between the LSB and USB frequency channel summing together to make a single IF channel. A slope in the gain across the side bands can introduce a calibration error when converting DSB intensity to SSB intensities, see figure 3. As HIFI has a large IF band width this effect becomes significant. The effect must be understood

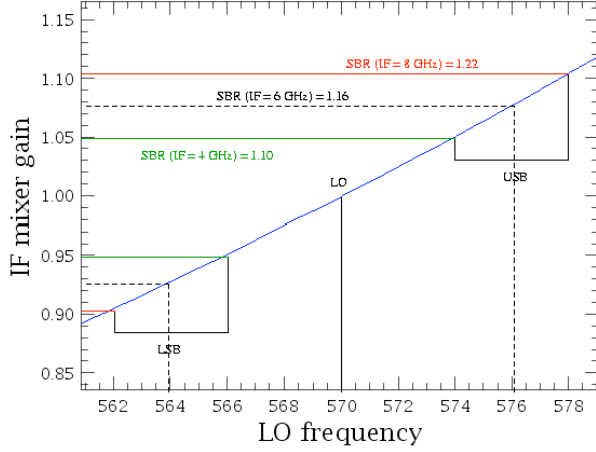

Figure 3. Example of linear mixer gain variation and the resulting side band ratios. The term SBR (side band ratio) is defined as USB gain divided by the LSB gain

in order to determine the calibration accuracy and eventually correct in the data processing pipeline.

The topic of intensity calibration is covered in detail in reference [8].

III. GAS CELL TEST SETUP

A. Principles

Gas cell tests were used by the SWAS satellite [9] and the Odin satellite [10] in their ground testing. SWAS in particular used a gas cell set up to demonstrate a side band gain ratio of unity. The IF bandwidth of SWAS of 1.4 GHz is considerably less than HIFI and hence would be less susceptible to side band gain imbalances.

The basic concept of a gas cell calibration of a heterodyne receiver is to observe well understood molecules (known line frequencies, intensities, pressure broadening parameters) and then using a radiative transfer model generate a model line profile. By comparing the model line profile with the observed line profile it is possible to extract the instrumental effects.

A gas cell observation follows that of a standard observation detailed in equation 2. A typical observation observes the hot and cold calibration loads through both the filled and empty gas cell. By forming a ratio of filled and empty observations one can extract the side band ratio. For a single spectral line in the lower side band, the filled and empty phases of the gas cell observation would be as follows:

$$S_{filled} = G_u(J_h - J_c) + G_l(J_h - J_c)e^{-\tau} \quad (3)$$

$$S_{empty} = G_u(J_h - J_c) + G_l(J_h - J_c) \quad (4)$$

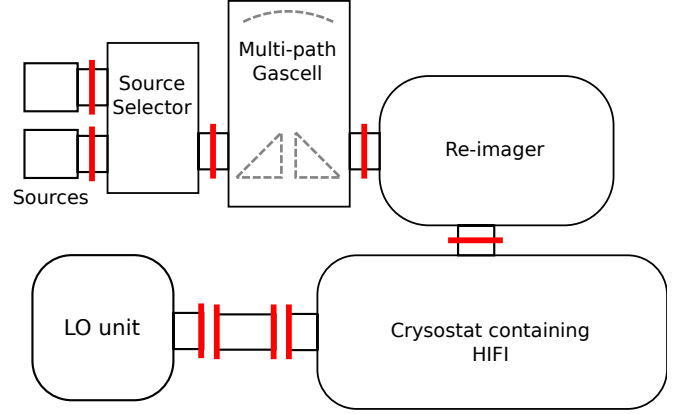

Figure 4. Gas test setup

where G_u and G_l are the frequency dependent upper and lower side band gain respectively, J_h and J_c are the effective hot and cold load temperature of a black body of temperature T at a given frequency. The $e^{-\tau}$ term represents the line opacity at the line center, see section IV. By rearranging equations 3 and 4 the side band ratio is given by:

$$R_G = \frac{G_l}{G_u} = \frac{1 - S_{filled}/S_{empty}}{S_{filled}/S_{empty} - e^{-\tau}} \quad (5)$$

For gases where the line intensity is saturated, $\tau \gg 1$, the above equation can be reduced to $S_{empty}/S_{filled} - 1$. For a gain balanced mixer S_{empty}/S_{filled} for a saturated line = 0.5 or an absorption line half the continuum level in a normalized spectra, see figure 6.

In the data processing pipeline the side band gains are applied to the DSB intensity to convert to single side band intensity. In an ideal gain balanced mixer this is simply a case of multiplying the intensity by two. Where the mixer sideband is not equal the intensity must be dividing by the side band gain factor which is defined for the upper side band as:

$$G_{ssb} = \frac{1}{1 + R_G} \quad (6)$$

and the lower side band gain factor is defined a $1 - G_{ssb}$, see reference [8].

B. Design

The design of the HIFI gas cell set up is detailed in reference [1]. The gas cell set up chosen was based on the recommendations from the SWAS gas cell setup [11]. The gas cell has a multi path optical set up which maximizes the optical path length while keeping the volume of the gas cell to minimum for ease of installation. The gas cell has a path length of

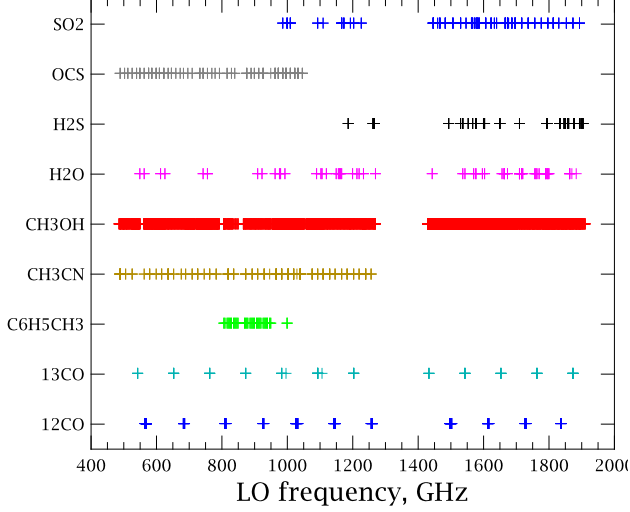

Figure 5. Summary plot showing LO frequency coverage of each gas used in the gas cell test campaign

128cm which is contained in a cylindrical vessel of 15 cm diameter and 50cm height.

As HIFI has a large frequency coverage one single molecule will not provide saturated lines at all frequencies. For the HIFI gas cell a range of molecules were observed and hence the effect of cross contamination was considered in the material choice for the gas cell. A glass gas cell design was chosen over a metal one as certain molecules would stick to the metal walls particularly water. The gas cell was designed to operate at low pressures around 1 millibar. The final gas cell test set up showing the calibration loads, re-imager, LO and HIFI cryostat is shown in figure 4.

C. Calibration gases

The choice of gases for the test campaign was a trade off between a number of criteria. For side band measurement a saturated line was necessary. This limited the gas choice to molecules with line intensities of 10^{-2} to 10^{-3} in units of $\text{nm}^{-2}.\text{MHz}$. Lab safety was also considered and possible corrosive effects on the gas cell itself. Figure 5 summarizes the frequency coverage of the final gas choices.

IV. GAS CELL LINE FITTING

A. Line profile theory

The line profile seen in figure 6 is best described using a voigt profile. The voigt profile is a convolution of a lorentzian and gaussian profile. The lorentzian profile describes the line broadening effect due to the gas pressure and its half width half

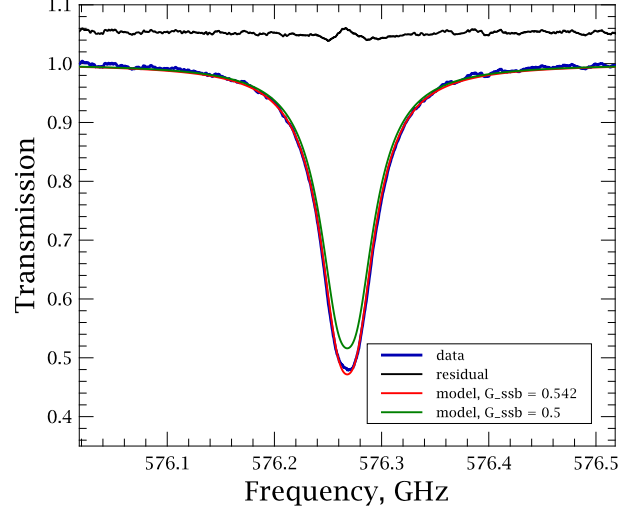

Figure 6. ^{12}CO gas cell data at 570.4 GHz (highlighted in blue on the left). Green line shows spectral line fit for a balanced mixer ($G_{ssb} = 0.5$), red line shows the fitted profile where $G_{ssb} = 0.542$

maximum is defined by the:

$$\delta\nu_L = \gamma_{self} P \quad (7)$$

where γ_{self} is the pressure broadening parameter MHz/mbar and P , the gas cell pressure, is in mbar. γ_{self} is taken from the HITRAN database [12]. The gaussian profile describes the broadening effect due to the thermal motion of the gas. The width of a gaussian profile is derived from the Boltzmann equation and is a function of the gas temperature and the line frequency. The half width half maximum is defined as:

$$\delta\nu_D = \frac{\nu_0}{c} \sqrt{\frac{2(\ln 2)kT}{m}} \quad (8)$$

where ν_0 is the line frequency, c is the speed of light, k is Boltzmann constant, T is the gas temperature and m is the molecular weight. The convolution of these 2 profiles gives the distribution of energy for that molecular transition. The integrated area of the voigt profile for that transition is then equal to the integrated intensity taken from the HITRAN or JPL catalogs for that line. The peak absorption is then defined as:

$$\alpha_{max} = \frac{I_{ba}}{\pi\delta\nu_L + \sqrt{\frac{\pi}{\ln 2} kT}} P \quad (9)$$

where I_{ba} is the integrated intensity taken from the catalog. Using α_{max} the unit voigt profile peak is scaled. Combining the scaled voigt with the exponential opacity broadening effect (Beer-Lambert law)

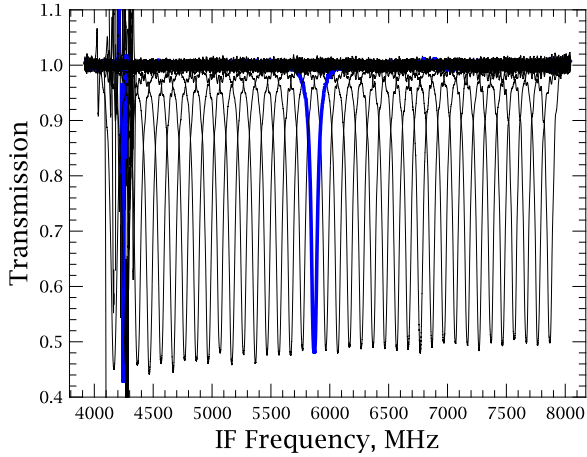

Figure 7. Plot of ^{12}CO (5-4) data taken with the V polarization wide band spectrometer (WBS) backend between 568.4 to 572.1 GHz in steps of 0.1 GHz at an average gas cell pressure of 6.5mbar. Traces of LO spurious signals can be seen between the LO frequencies of 570.7 and 568.4 GHz around the IF frequency of 4.3GHz. The spectra highlighted in blue is shown in more detail in figure 6

due to gas column length, the final line profile profile peak is:

$$e^{\alpha_{max} V(\nu - \nu_0, \delta\nu_D, \delta\nu_L) L} \quad (10)$$

where L is the gas cell column length. The residual between this line profile and the observed line is taken to be the side band gain ratio.

B. Line profile fitting

Figure 6 shows a example of the line fitting routine. The green profile shows the line profile for a balanced mixer while the red profile shows line profile where the side band gain is left as a free parameter which is fitted to match the observed line profile. The resulting side band ratio factor is 0.542, see equation 6.

Figure 7 shows an overview of the ^{12}CO 576.268 GHz spectral line for a range of LO Frequencies between 568.4 and 572.1 GHz. Each of spectra was fitted with a model spectral line where the side band gain was a free parameter. The resulting fitted side band ratio factor versus LO Frequency is shown in figure 8.

Note that the band 1b data presented here is an exceptional example with a large side band gain difference over 4GHz. This extreme example was chosen to demonstrate the gas cell method and is not typical of the side band ratio determined from ^{12}CO line fitting in other bands.

V. CORRECTION OF FLIGHT DATA

The main goal of the gas cell test campaign was to determine the side band ratio across each mixer band and eventually correct flight data for this effect. The main assumption made was that the side band ratio is an inherent part of the mixer set up and should remain the same over the instrument life time. The example presented here is an extreme side band ratio compared with other LO frequencies in HIFI. A 10% change in gain is seen across over 4 GHz of the IF band. This makes it an ideal region to compare the lab data presented here with a comparable spectral scan observed in space.

During the first performance verification phase of HIFI in July 2010 a number of spectral scan observations on strong sources were taken. Figure 9 shows a ^{12}CO line tracked across the IF band in steps of 0.4 GHz between the LO frequencies 568.535 and 571.932 GHz. In this plot it is apparent that the same slope in gain seen in the gas cell data is seen in the flight. Ideally the spectral line intensity should be the same across the IF band, however in figures 7 and 9 the line intensity is seen to decrease across the IF band indicating a side band gain imbalance. More significantly is that the slope in gain across the IF seen in flight data is consistent with that seen in the gas cell data.

Figure 10 shows the peak line intensity of the data show in figure 9 and also the peak line intensities when the side band gain shown in figure 8 is applied. From this plot one can see that before the gain correction is applied the peak intensity scatter is $\sim 10\%$ while after gain correction it is greatly reduced to $\sim 3\%$.

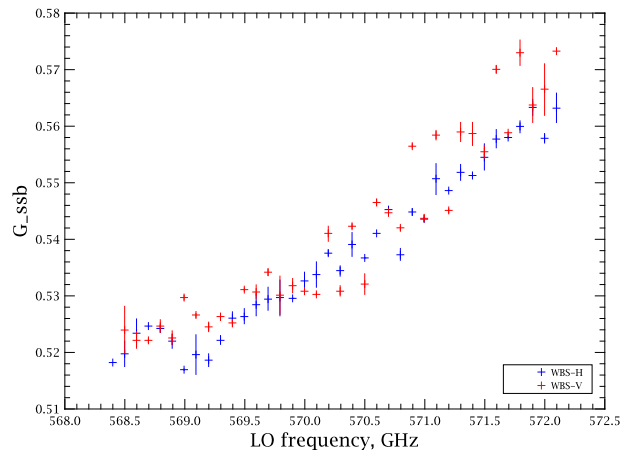

Figure 8. Fitted $G_{s, sb}$ for each line profile shown in figure 7 versus LO Frequency

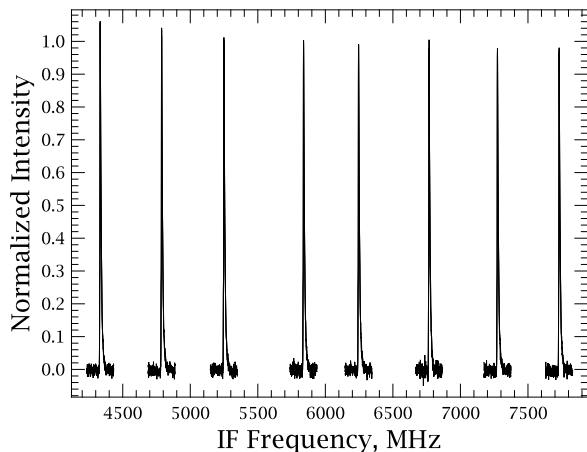

Figure 9. Flight data spectral scan showing the ^{12}CO (5-4) line for a range of LO frequencies from 568.535 to 571.932 GHz

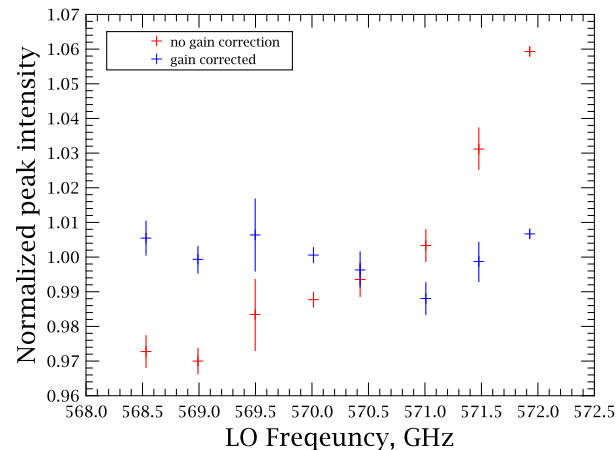

Figure 10. Peak line intensity with and without gain correction. Notice the variation in intensity scatter is reduced from 10% to 3%

VI. CONCLUSIONS

In this paper, the concept of calibrating a double side band heterodyne spectrometer using a gas cell test set up was described. It was shown how to generate a model spectra using radiative transfer methods taking into account the optical path length, gas pressure and temperature coupled with the JPL and HITRAN line catalogs. We described how by comparing model spectra to observed spectra the side band ratio at that IF frequency could be extracted. Using this extracted side band ratio data we showed that for the LO frequency range from 568 to 572 GHz the amount of scatter in a flight data could be reduced from the $\sim 10\%$ to $\sim 3\%$.

VII. FUTURE WORK

The data covered in this paper is only a small fraction of the total data taken during the gas cell campaign, see figure 5. Future work will involve the expansion of the methods demonstrated here to ^{12}CO and ^{13}CO in other mixer bands. The final goal of this work is to analyze the large CH_3OH and CH_3CN dataset taken and generate a more complete picture of the side band gain ratio, thereby improving the overall calibration accuracy of HIFI and finally helping produce exceptional science data.

VIII. ACKNOWLEDGMENTS

A portion of this research was performed at the Jet Propulsion Laboratory, California Institute of Technology, under contract with the National Aeronautics and Space Administration.

REFERENCES

- [1] D. Teyssier, E. Dartois, D. Deboffle, J. Crussaire, Y. Longval, F. Boulanger, and M. Pérault, "A Multi-path Far-Infrared and Sub-millimetre Gas Cell for Spectral Tests of Herschel-HIFI," in *15th International Symposium of Space Terahertz Technology, Northampton, Massachusetts, 2004*, pp. 306–312.
- [2] T. de Graauw, N. Whyborn, F. Helmich, P. Dieleman, P. Roelfsema, E. Caux, T. Phillips, J. Stutzki *et al.*, "The Herschel-Heterodyne Instrument for the Far-Infrared (HIFI):instrument and pre-launch testing," in *Space Telescopes and Instrumentation 2008: Optical, Infrared, and Millimeter*, J. M. Oschmann, Jr., M. W. M. de Graauw, and H. A. MacEwen, Eds., vol. 7010, no. 1. SPIE, 2008, p. 701004. [Online]. Available: <http://link.aip.org/link/?PSI/7010/701004/1>
- [3] J. Zmuidzinas and P. Richards, "Superconducting detectors and mixers for millimeter and submillimeter astrophysics," *Proceedings of the IEEE*, vol. 92, no. 10, pp. 1597–1616, Oct. 2004.
- [4] O. Siebertz, C. Honingh, T. Tils, C. Gal, M. Olbrich, R. Bieber, F. Schmuelling, and R. Schieder, "The Impact of Standing Waves in the LO path of a Heterodyne Receiver," in *18th International Symposium of Space Terahertz Technology, California Institute of Technology, Pasadena, California, 2007*, pp. 117–122.
- [5] C. Comito and P. Schilke, "Reconstructing reality: Strategies for sideband deconvolution,"

- A&A, vol. 395, pp. 357–371, Nov. 2002.
- [6] J. Kooi and V. Ossenkopf, “HIFI Instrument Stability as Measured during the Thermal Vacuum Tests of the Herschel Space Observatory,” in *20th International Symposium of Space Terahertz Technology, Charlottesville, Virginia*, 2009, p. 69.
- [7] R. D. Higgins and J. W. Kooi, “Electrical standing waves in the HIFI HEB mixer amplifier chain,” in *Society of Photo-Optical Instrumentation Engineers (SPIE) Conference Series*, ser. Society of Photo-Optical Instrumentation Engineers (SPIE) Conference Series, vol. 7215, Feb. 2009.
- [8] V. Ossenkopf, “The Intensity Calibration Framework for HIFI,” *ALMA Memo 442*, Jan. 2003.
- [9] V. Tolls, G. J. Melnick, M. L. N. Ashby, E. A. Bergin, M. A. Gurwell, S. C. Kleiner, B. M. Patten, R. Plume *et al.*, “Submillimeter Wave Astronomy Satellite Performance on the ground and in orbit,” *ApJS*, vol. 152, pp. 137–162, May 2004.
- [10] U. Frisk, M. Hagström, J. Ala-Laurinaho, S. Andersson, J. Berges, J. Chabaud, M. Dahlgren, A. Emrich *et al.*, “The Odin satellite. I. Radiometer design and test,” *A&A*, vol. 402, pp. L27–L34, May 2003.
- [11] R. Schieder, “The usefulness of a gas cell for performance testing,” *Tech. Rep. SWAS/TM-4027*, 1993.
- [12] L. S. Rothman, I. E. Gordon, A. Barbe, D. C. Benner, P. F. Bernath, M. Birk *et al.*, “The HITRAN 2008 molecular spectroscopic database,” *Journal of Quantitative Spectroscopy and Radiative Transfer*, vol. 110, pp. 533–572, Jun. 2009.